

1

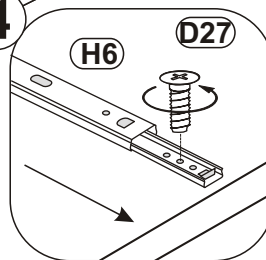

2

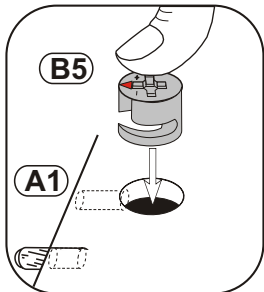
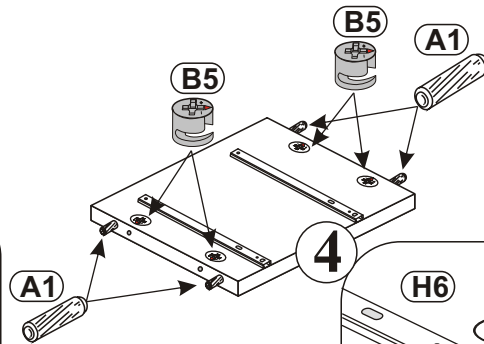
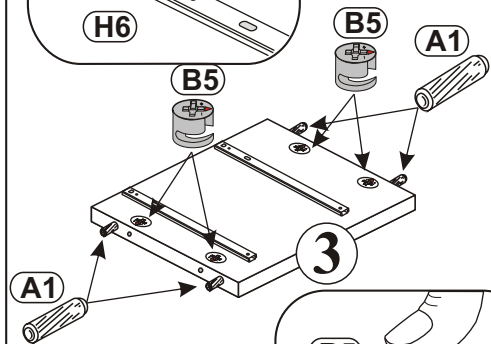
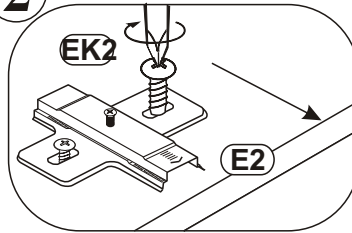
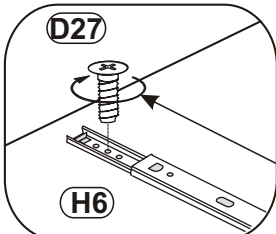
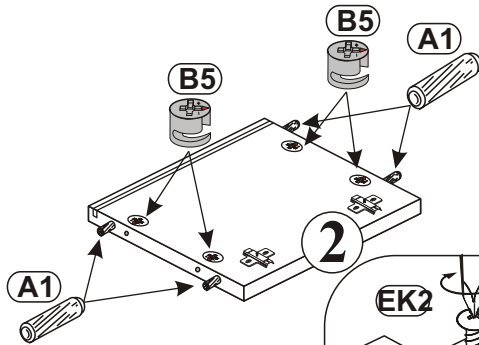
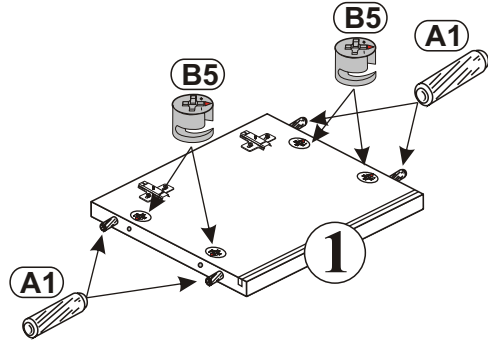
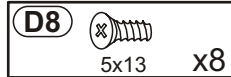
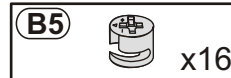
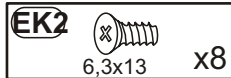
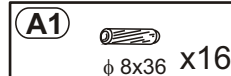
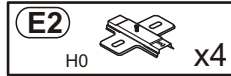
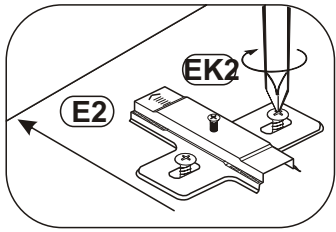
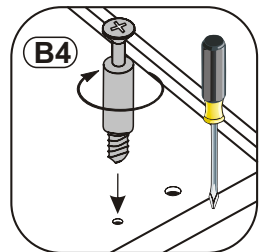
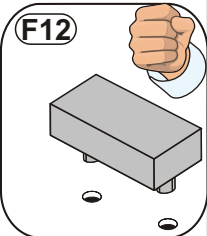
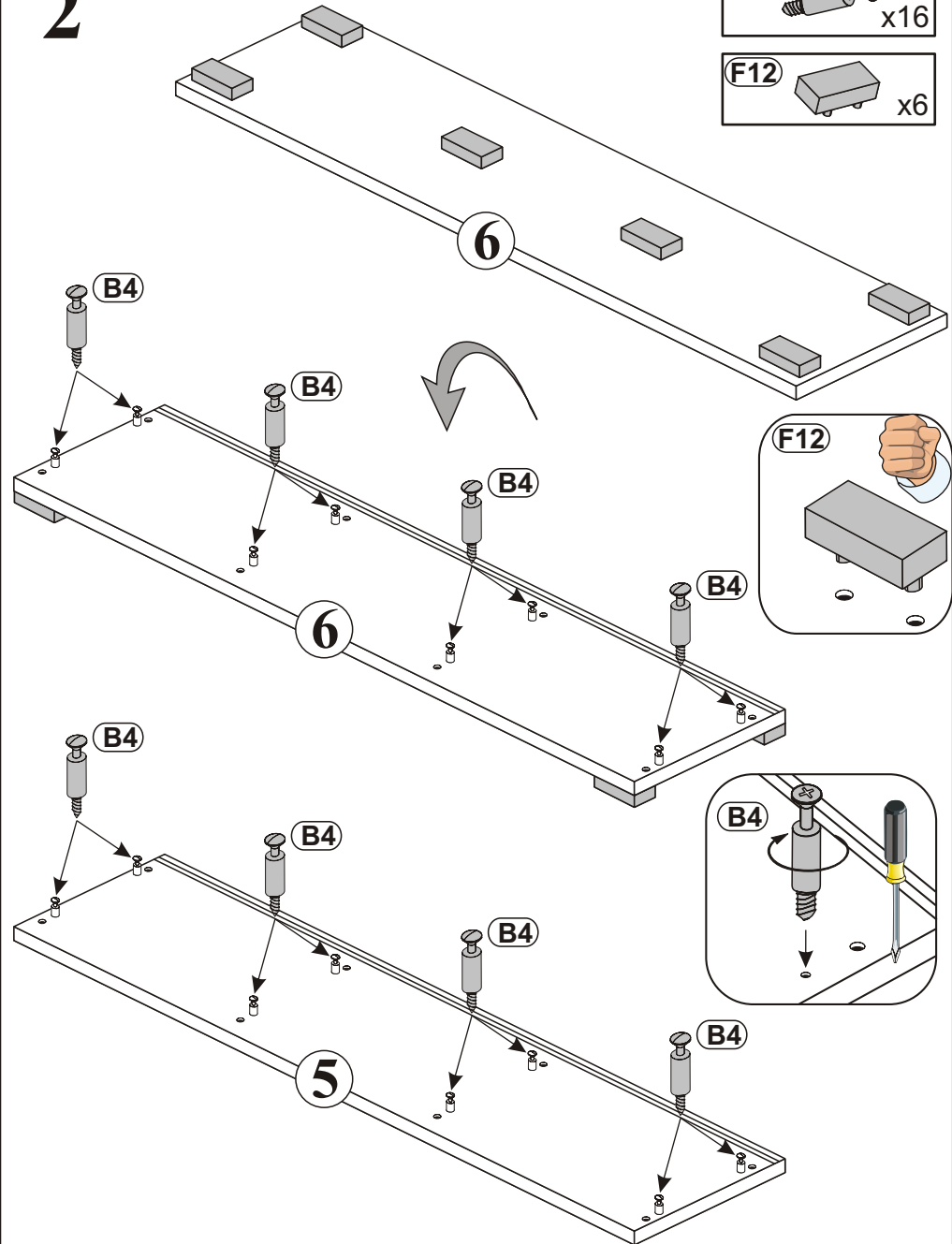
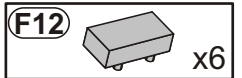
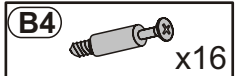

3

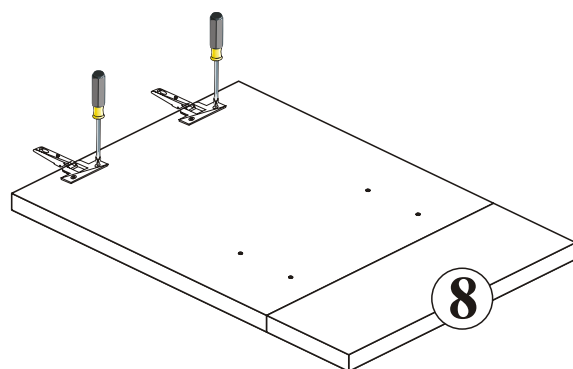
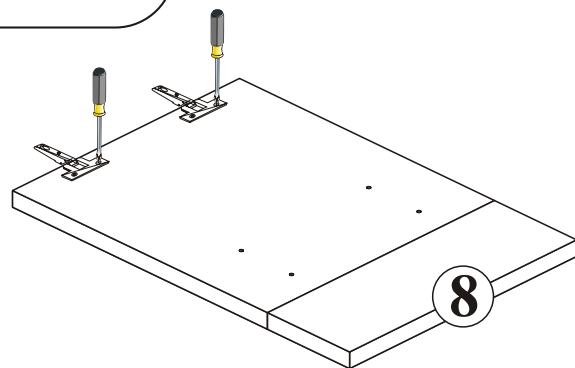
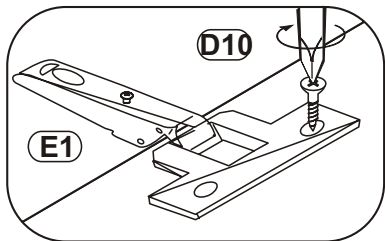
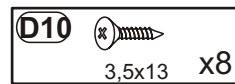
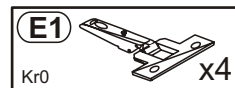

4

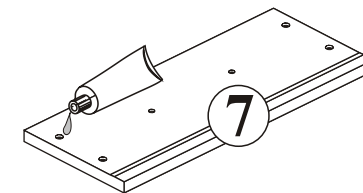
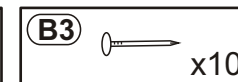
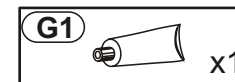
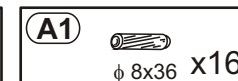
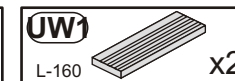
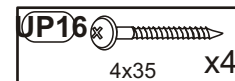

x2

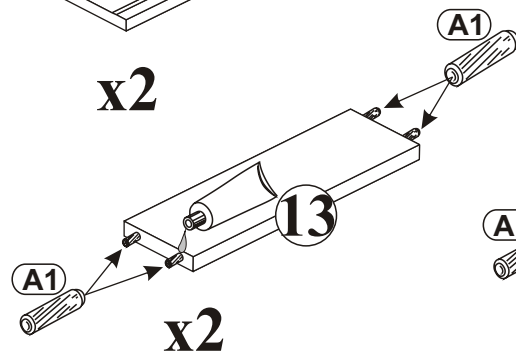

x2

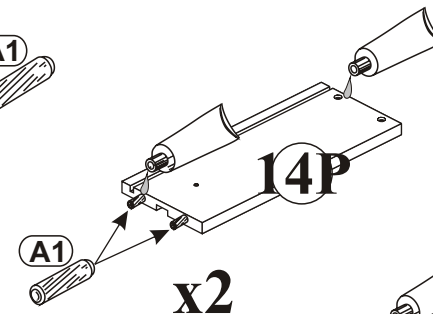

x2

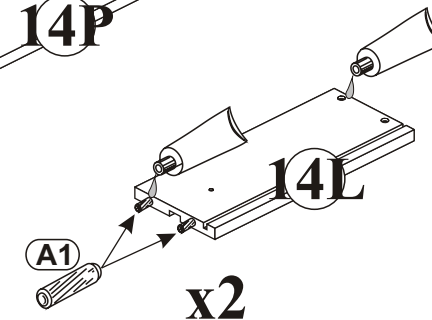

x2

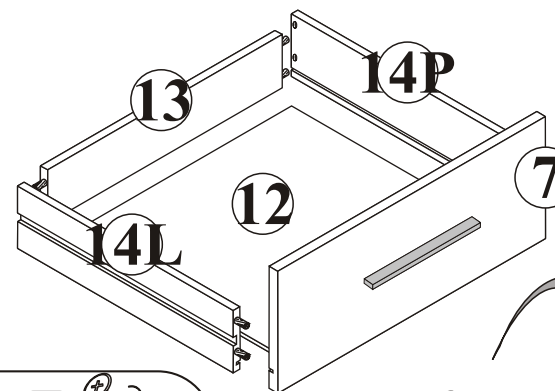

x2

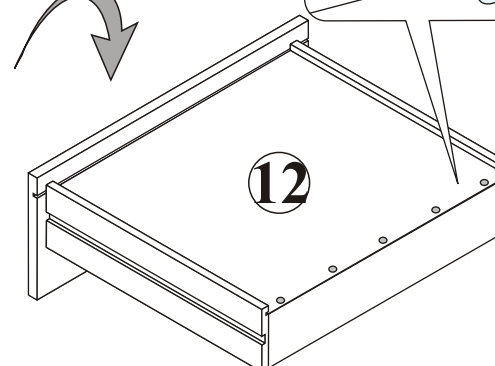
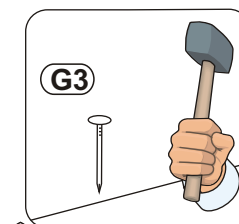
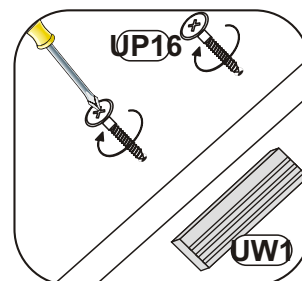

5

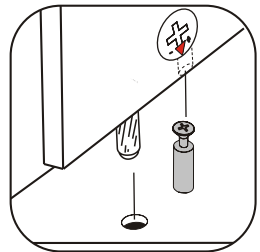
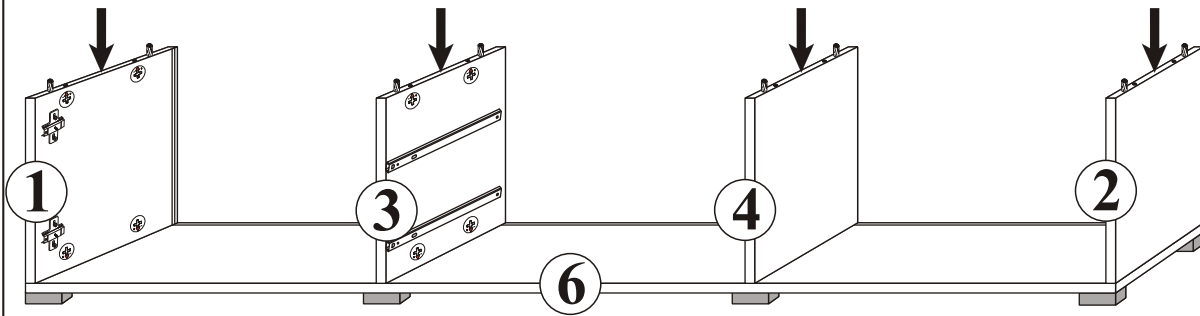

6

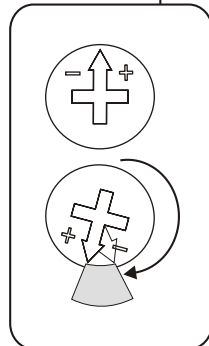
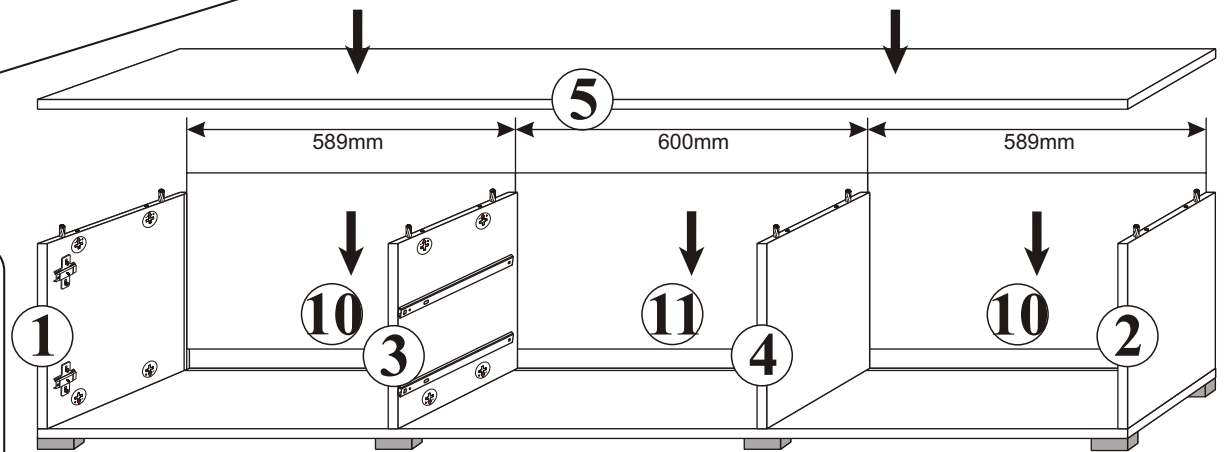
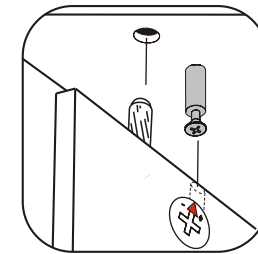

7

a=b

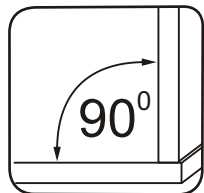
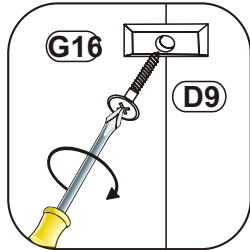
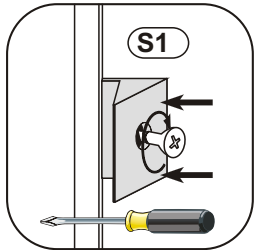
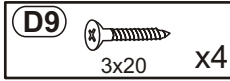
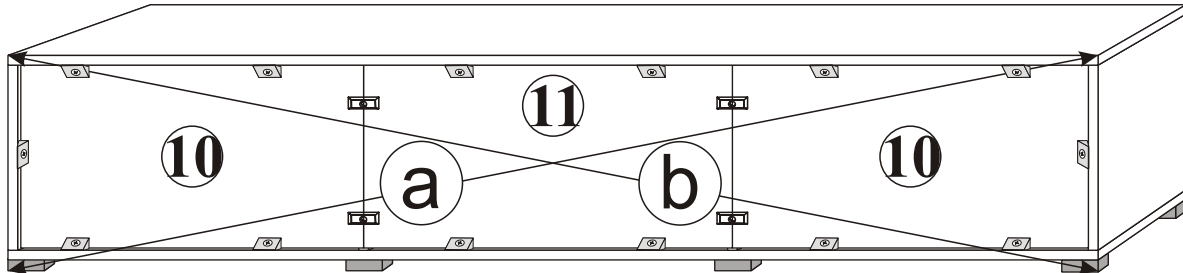

8

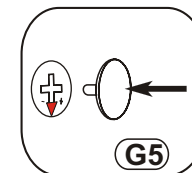
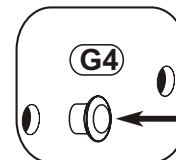
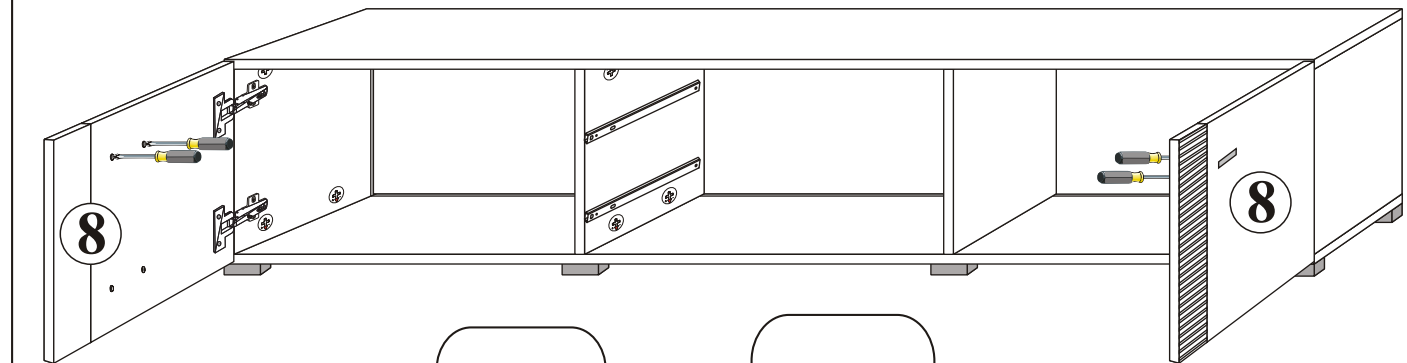
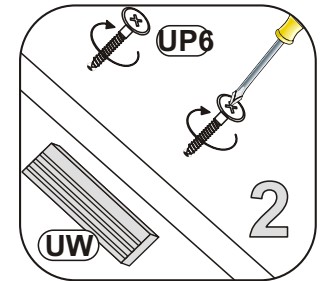
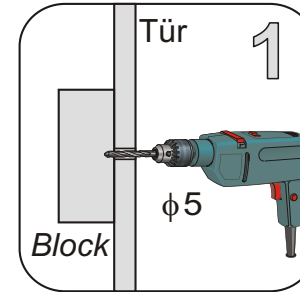
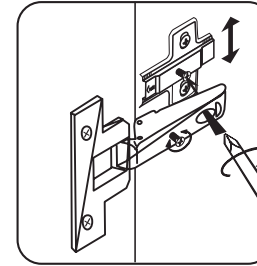
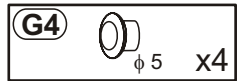
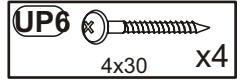
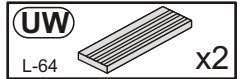

9

D18
M4x9mm x4

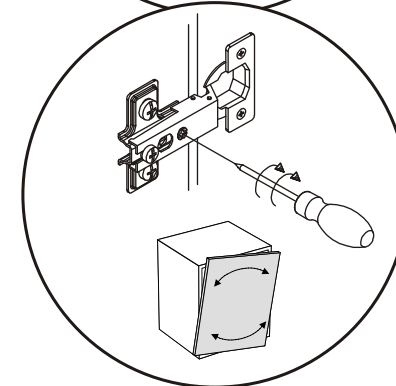
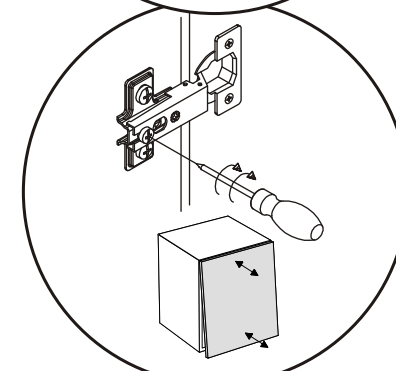
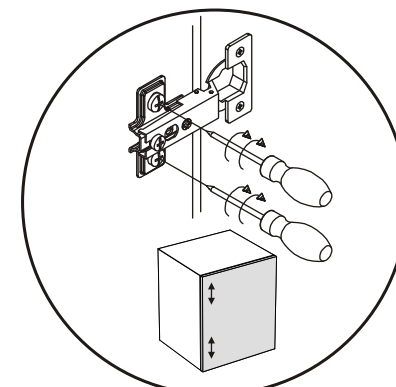
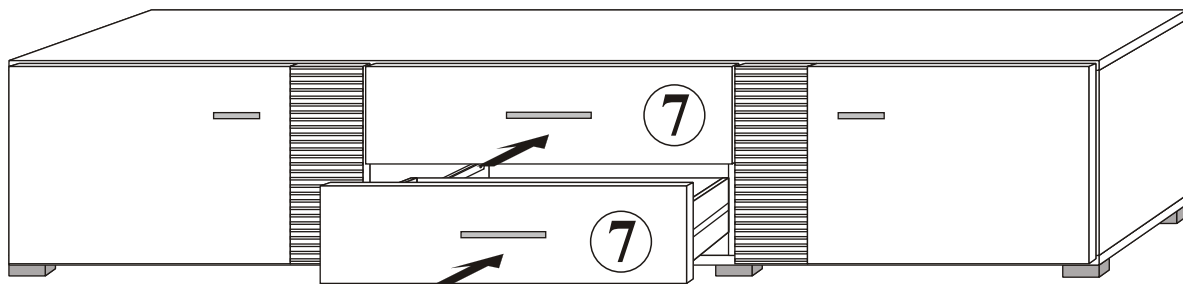
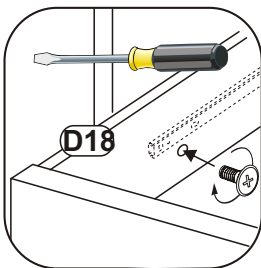

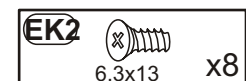
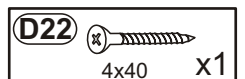
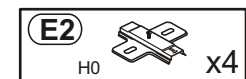
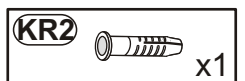
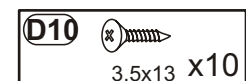
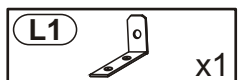
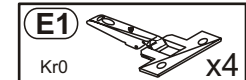
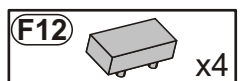
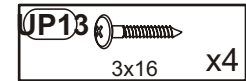
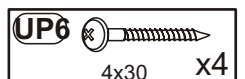
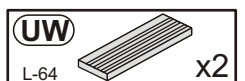
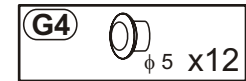
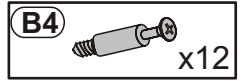
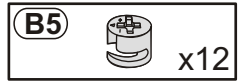
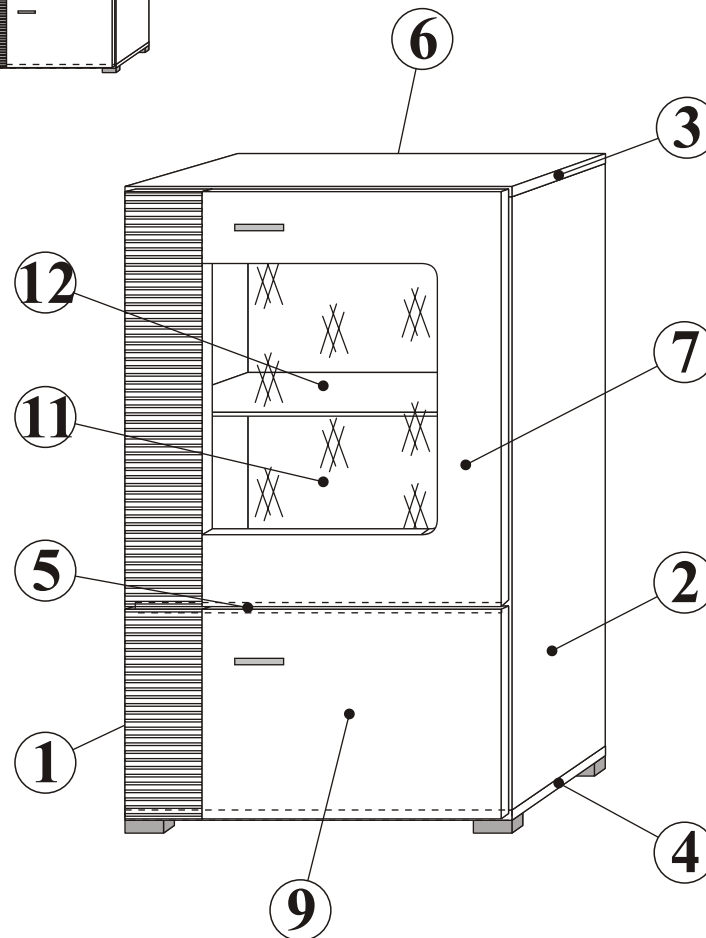
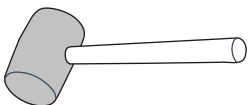
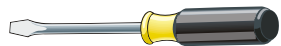
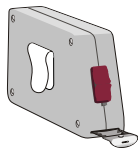
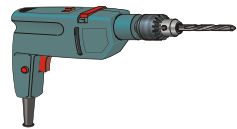
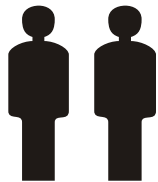
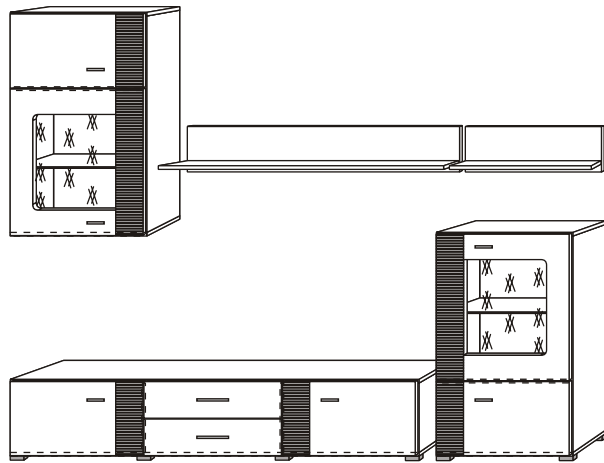

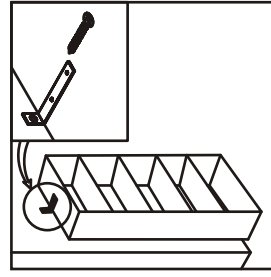
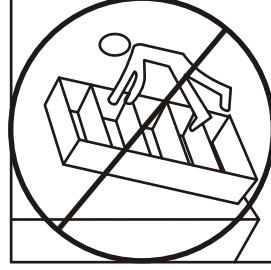
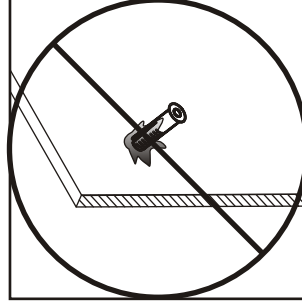
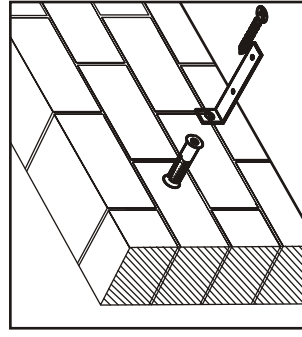
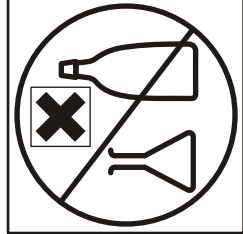
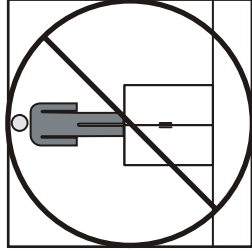
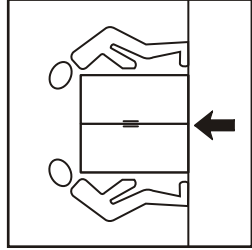
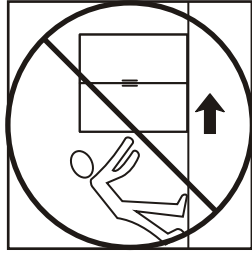
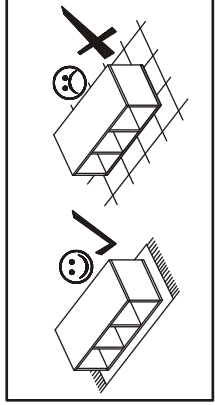
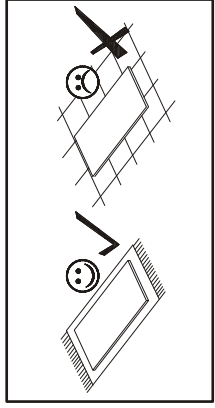
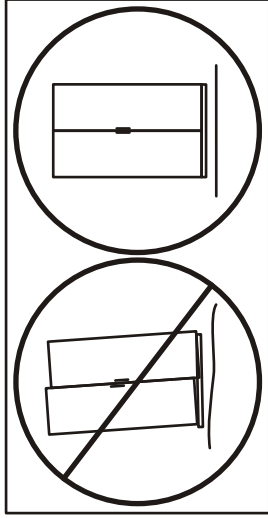
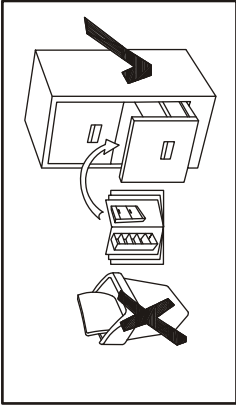
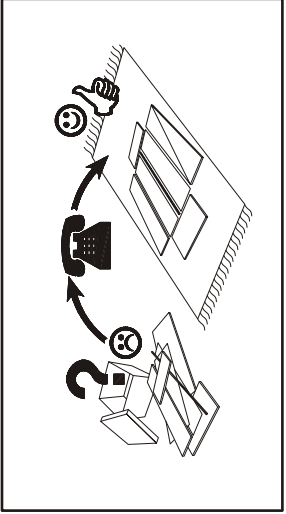

1

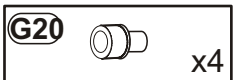
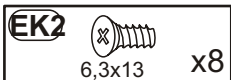
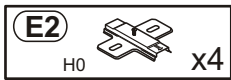
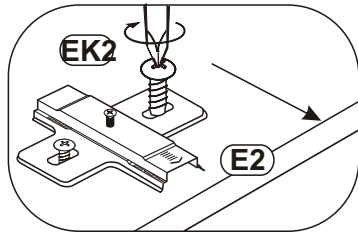
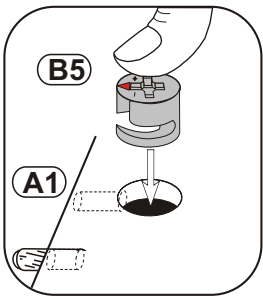
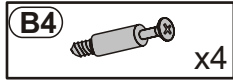
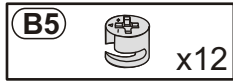
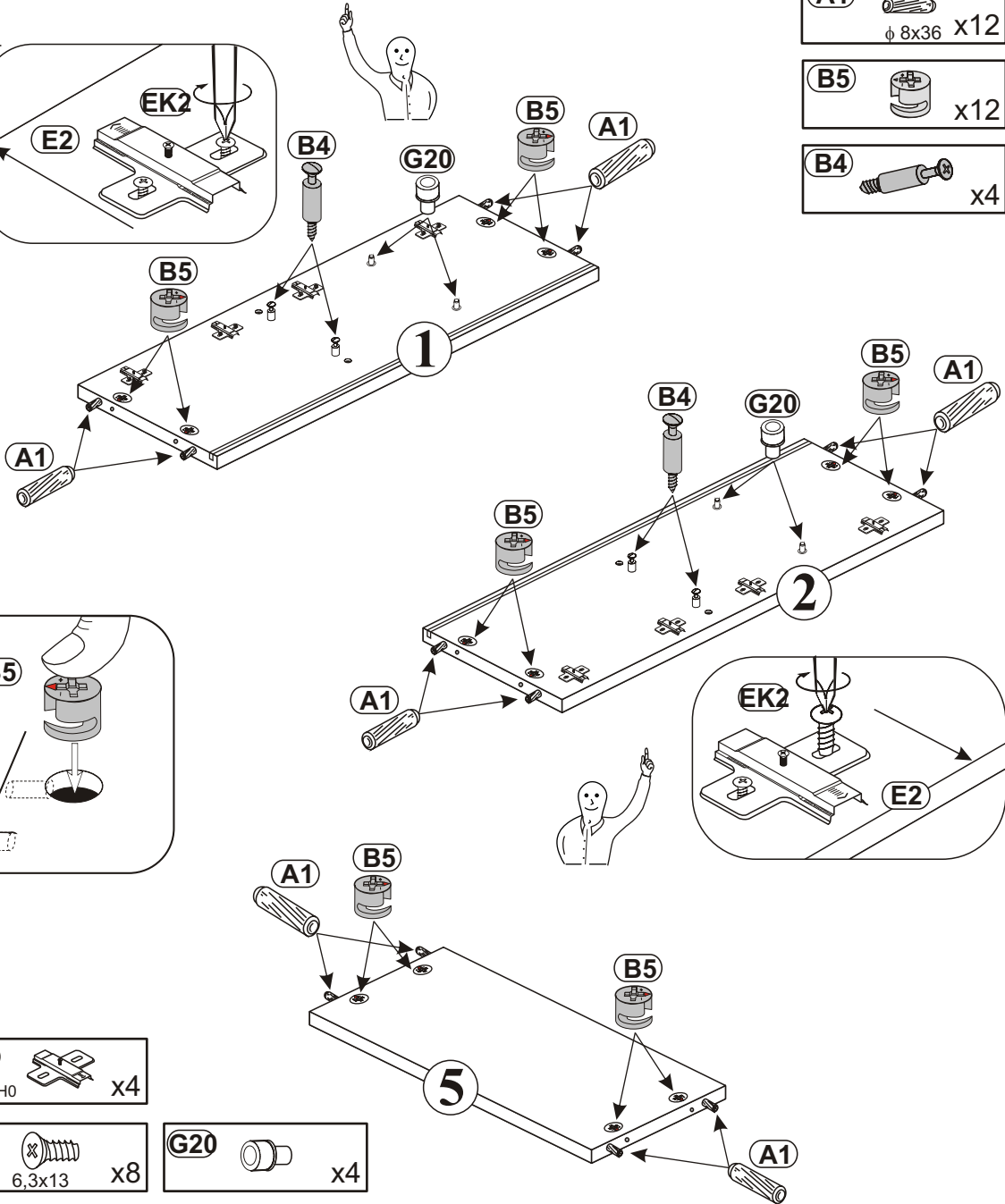
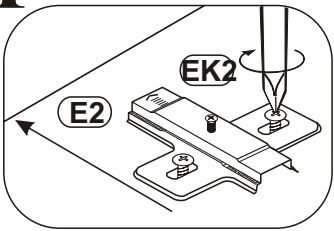

2

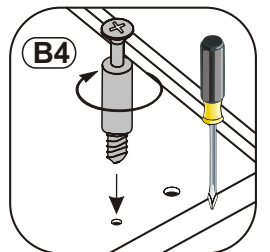
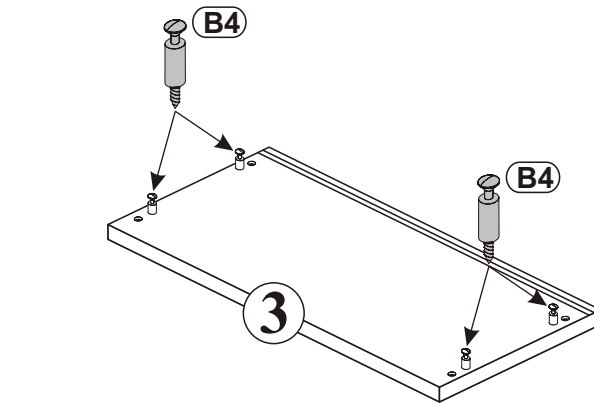
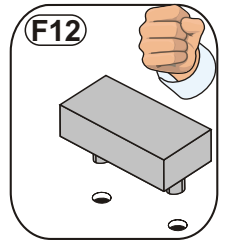
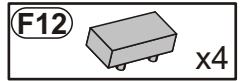
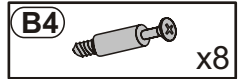
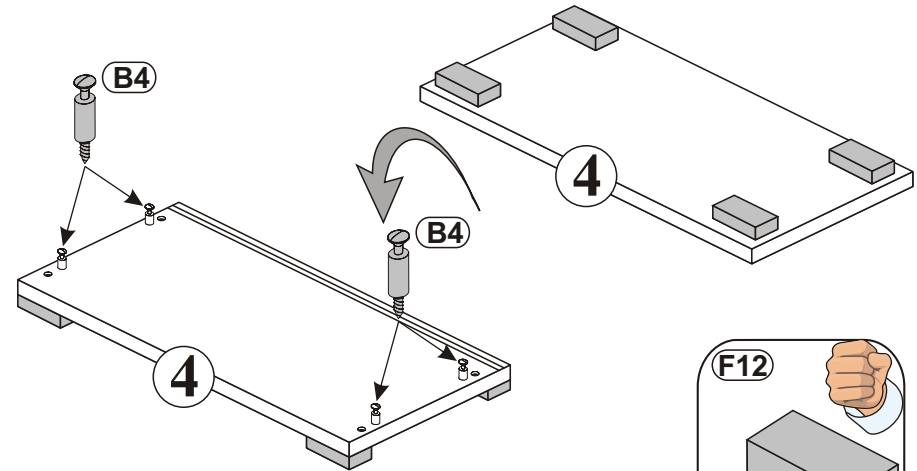

ALLEPO

TYP 40

3

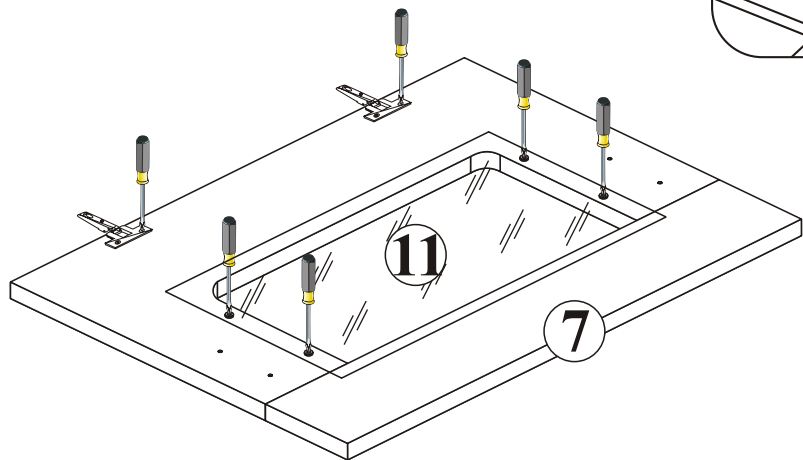
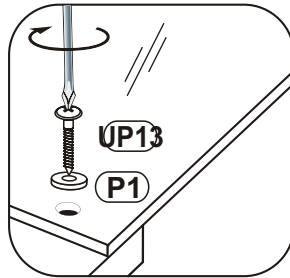
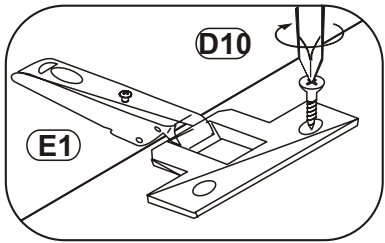
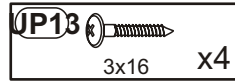
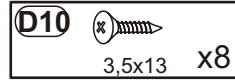
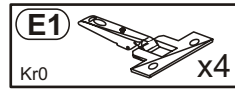
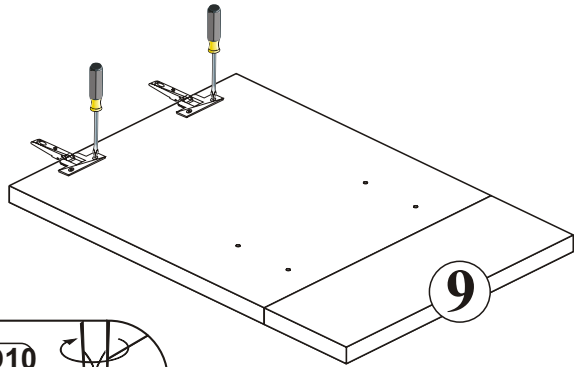

11

7

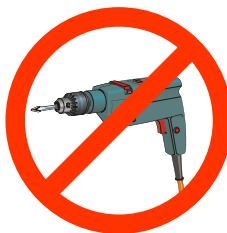

24 __ AL

4/7

4

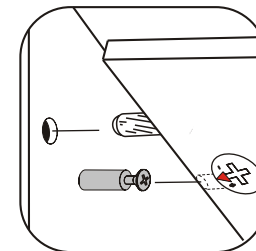
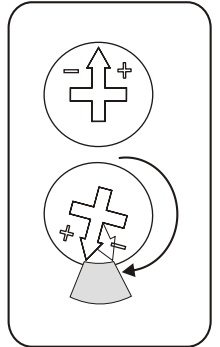
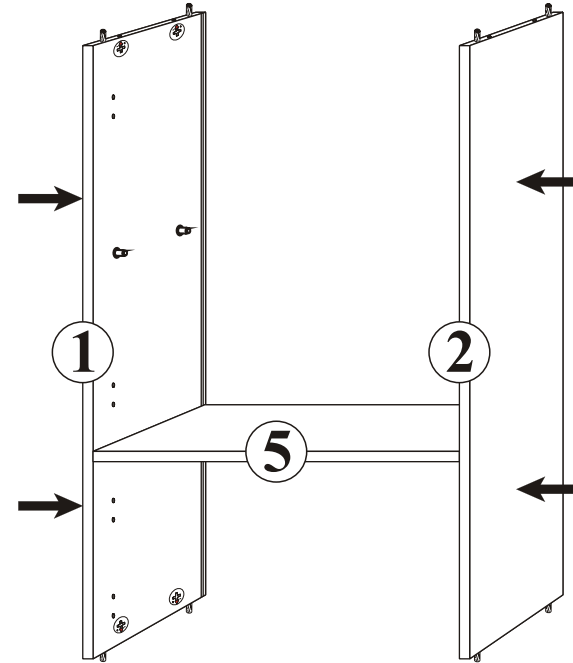

5

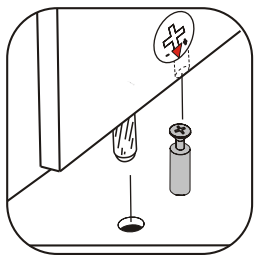
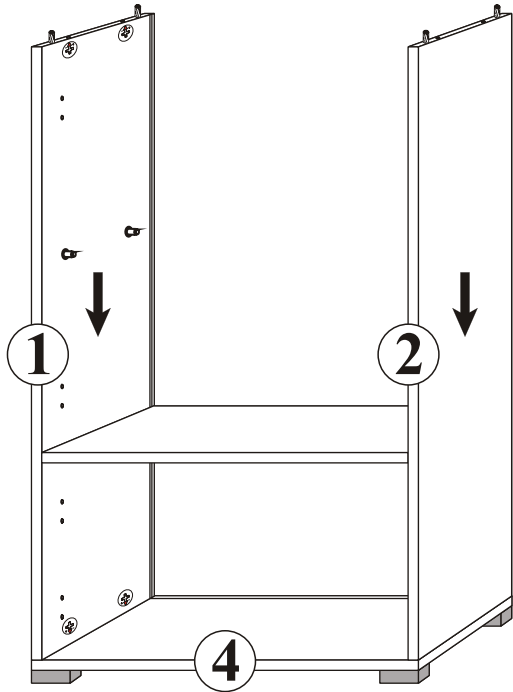

6

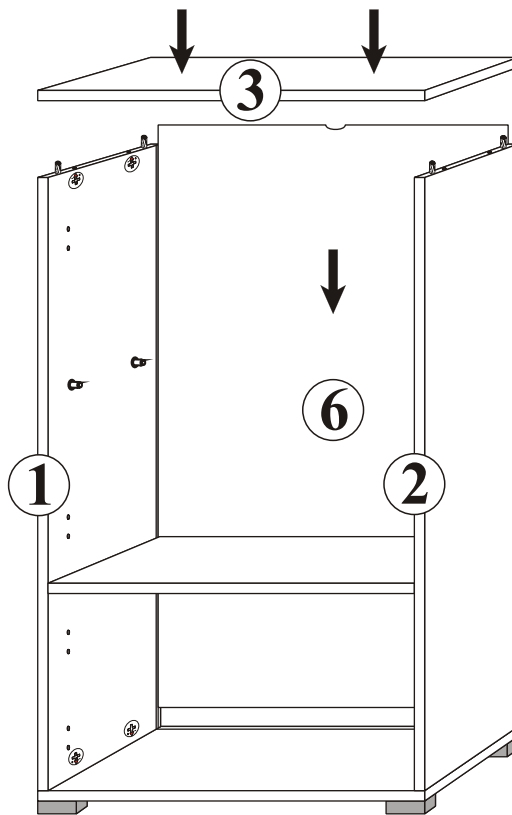
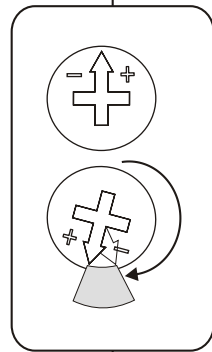
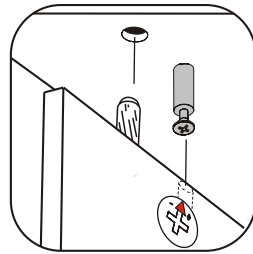

7



a=b

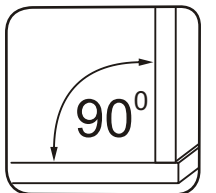
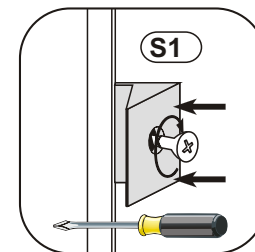
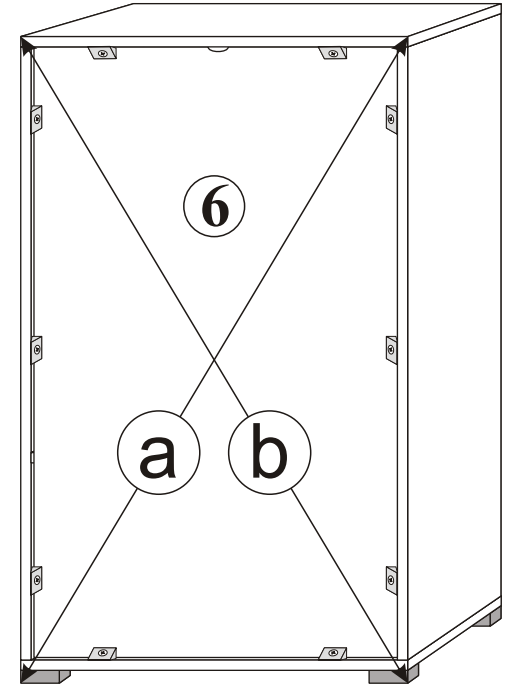



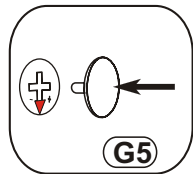
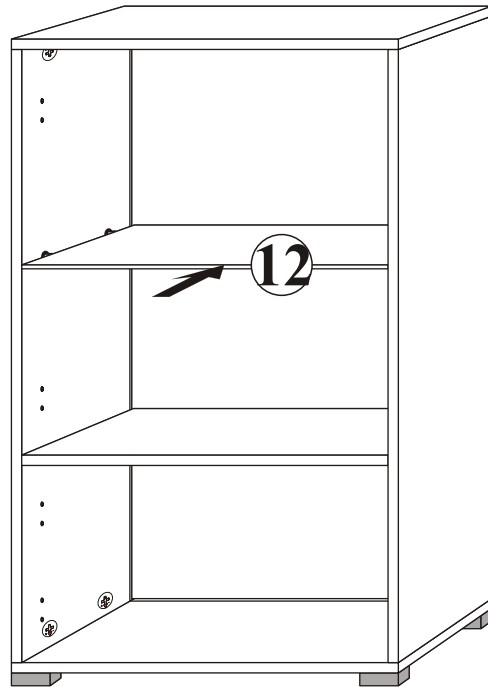

8

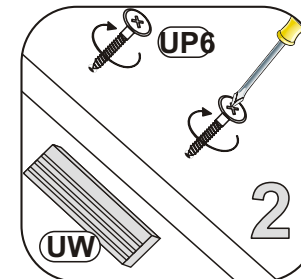
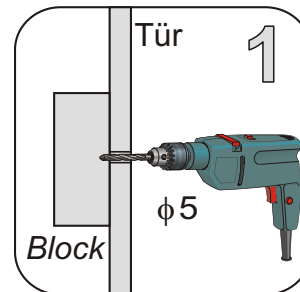
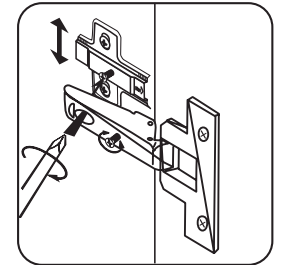
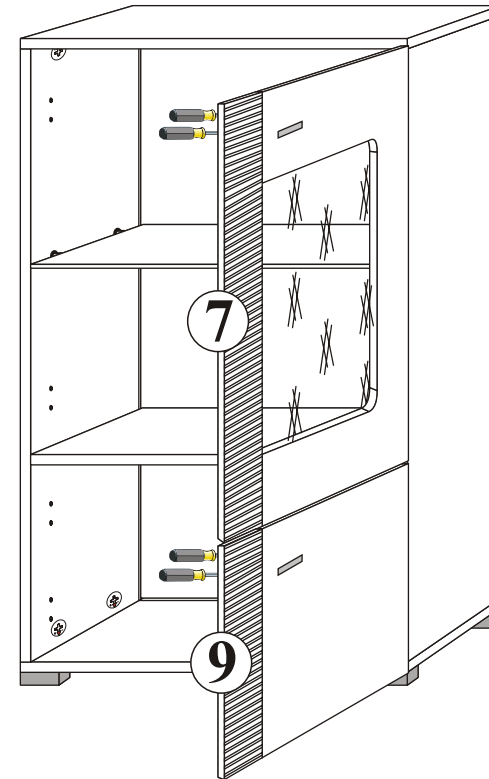
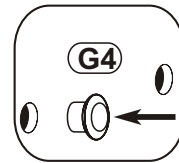
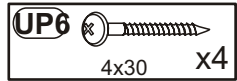
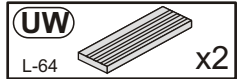
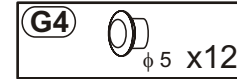

9



10

- D10**  3,5x13 x2
- L1**  x1
- KR2**  x1
- D22**  4x40 x1

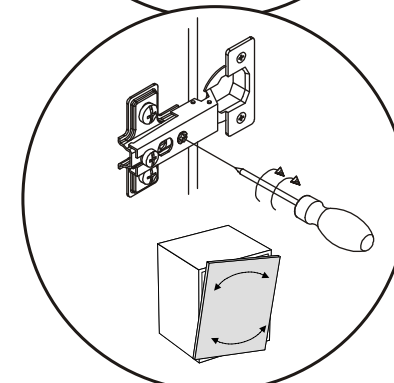
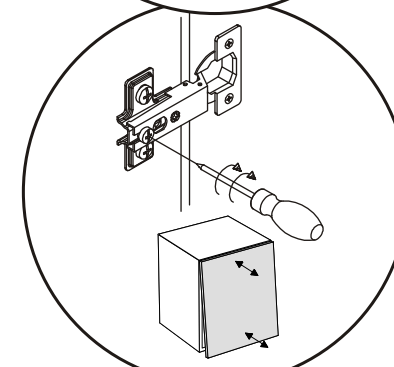
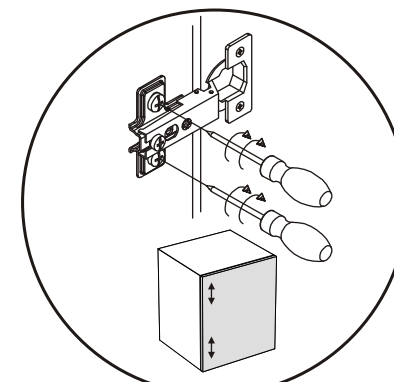
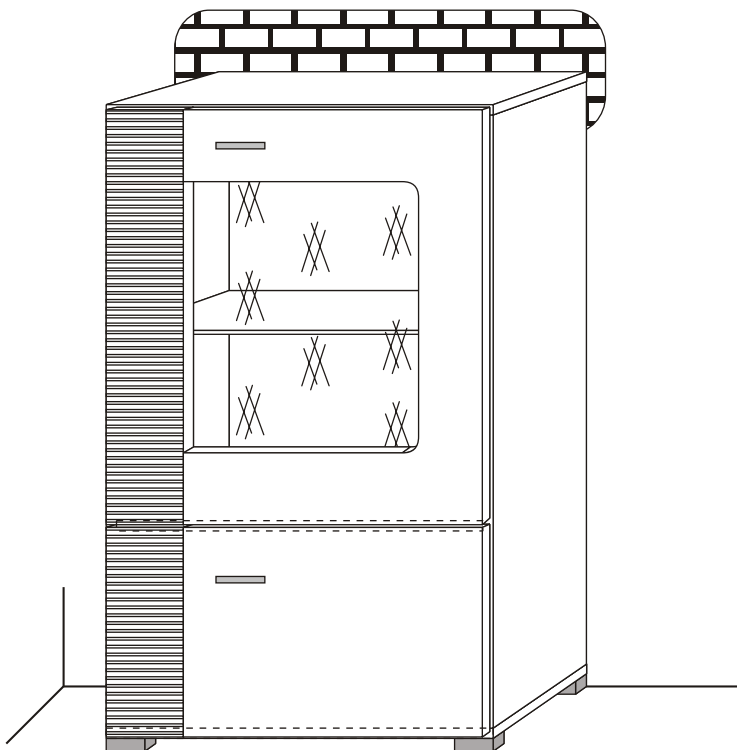
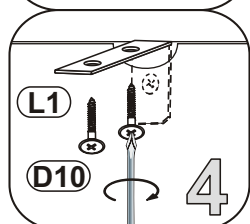
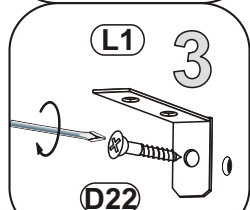
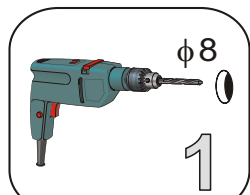

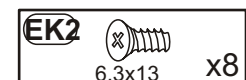
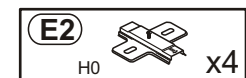
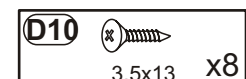
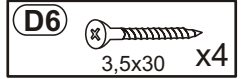
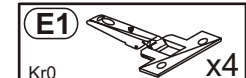
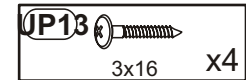
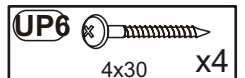
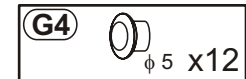
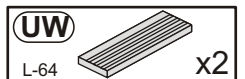
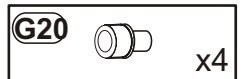
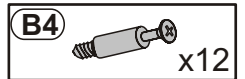
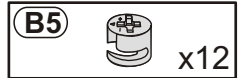
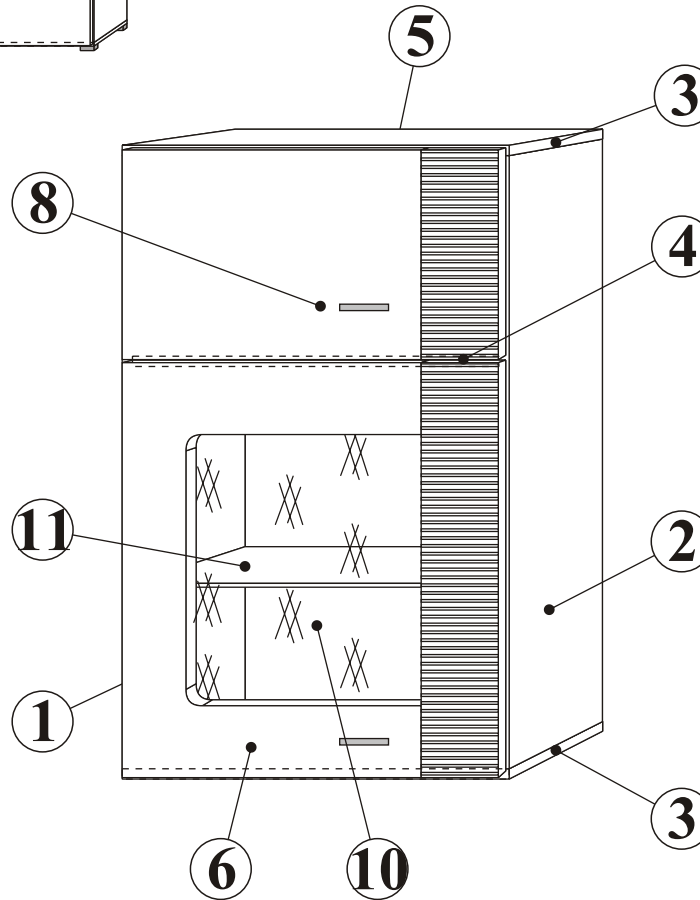
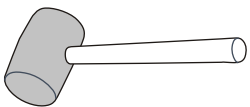
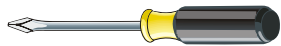
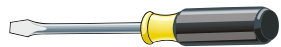
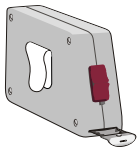
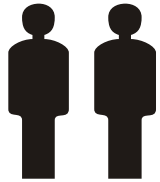
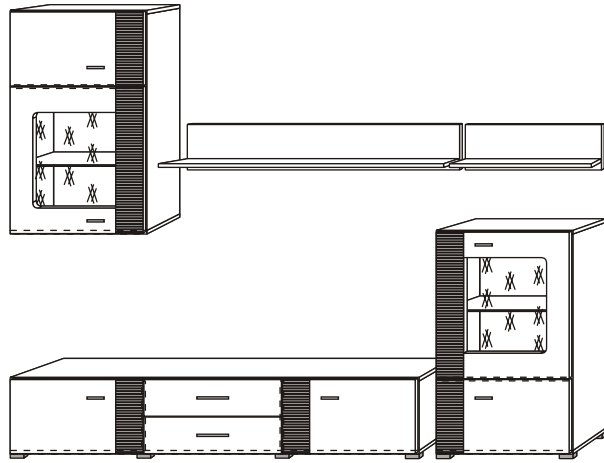

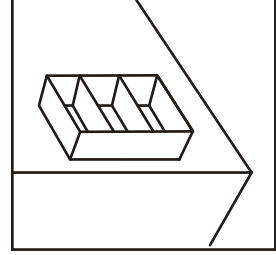
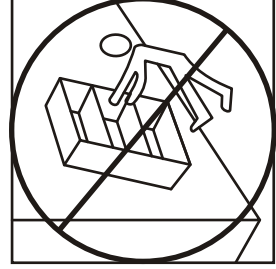
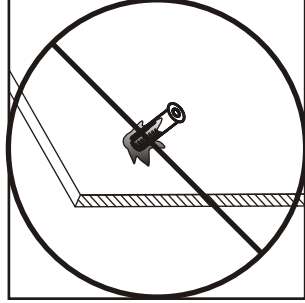
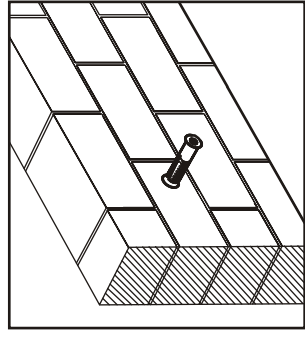
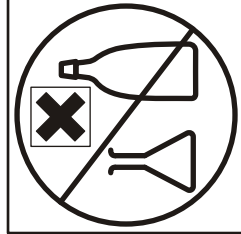
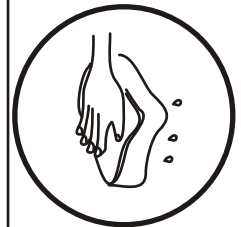
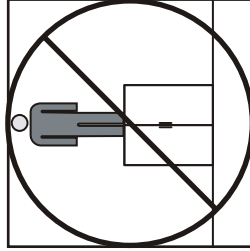
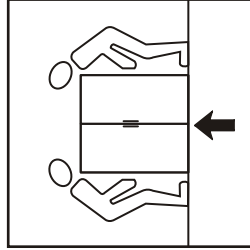
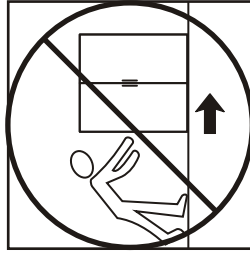
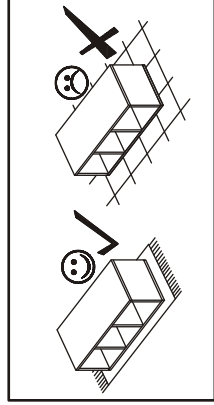
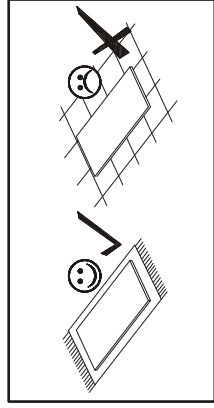
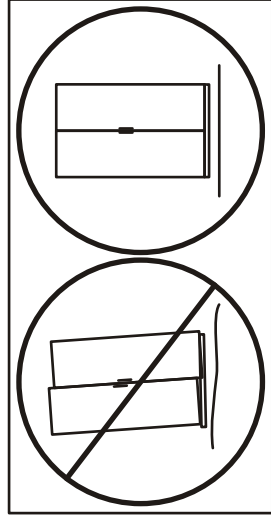
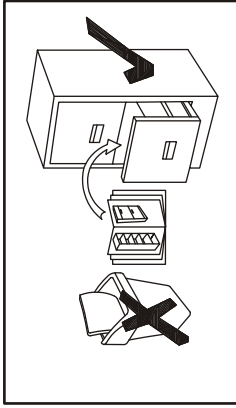
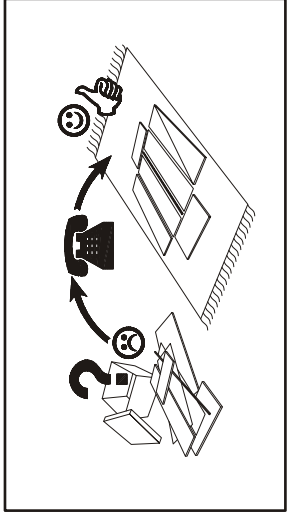

1

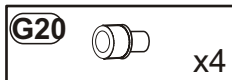
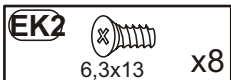
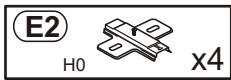
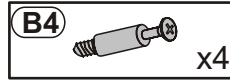
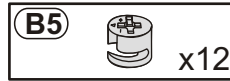
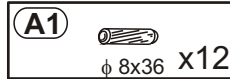
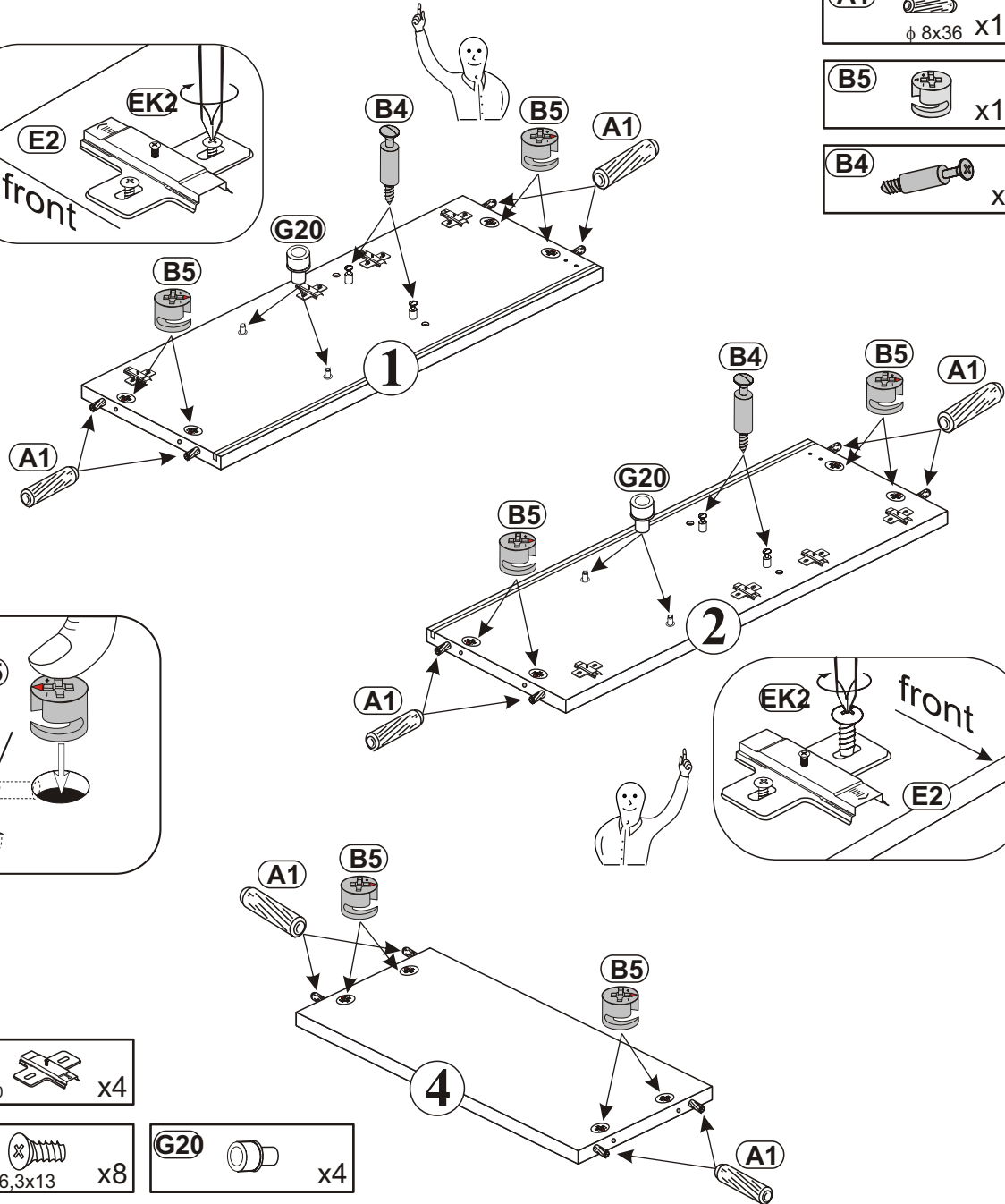
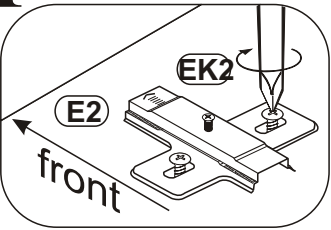

2

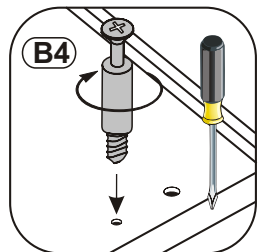
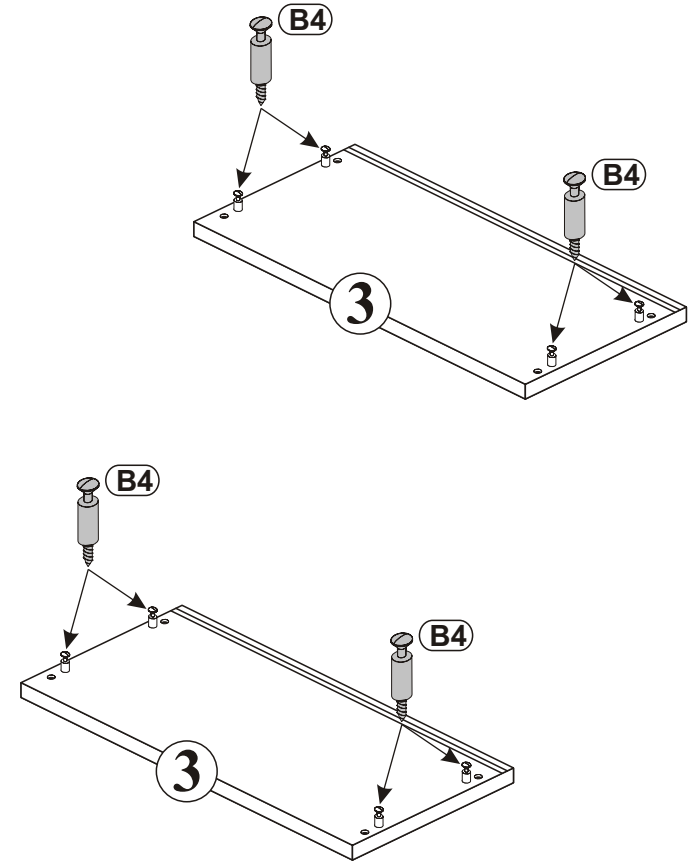
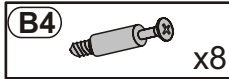

3

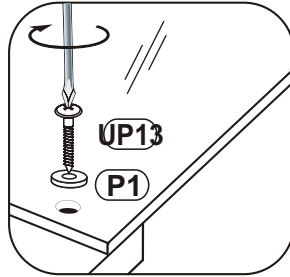
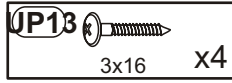
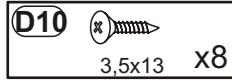
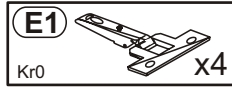
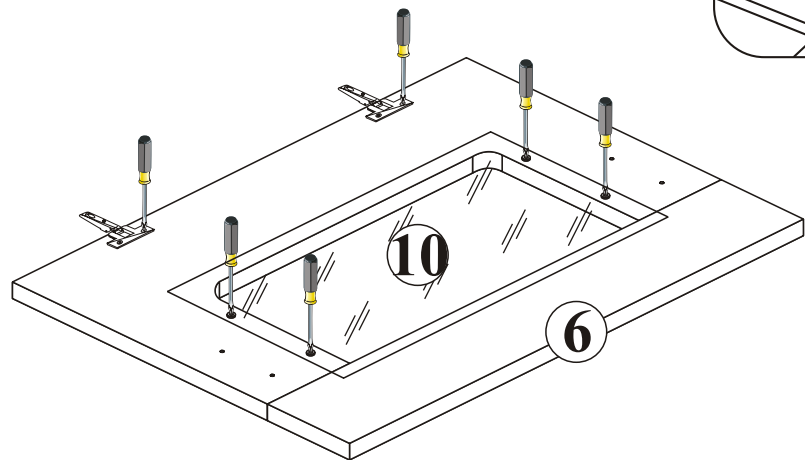
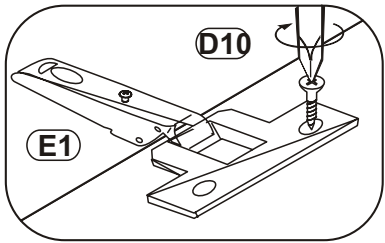
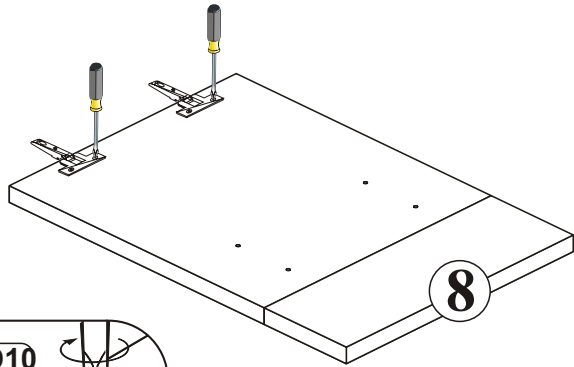

4

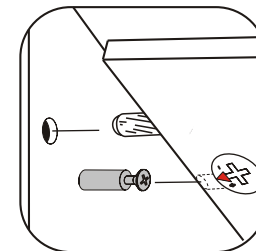
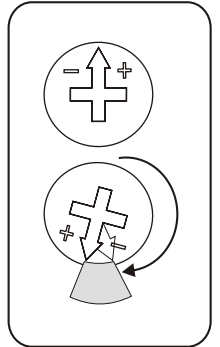
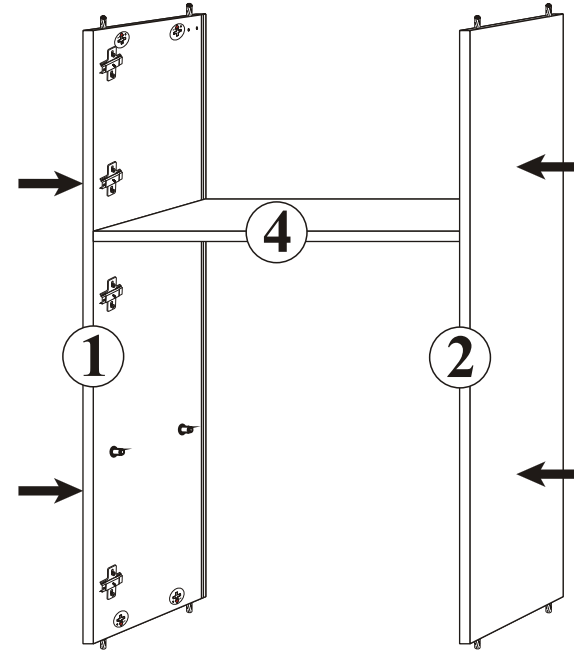

5

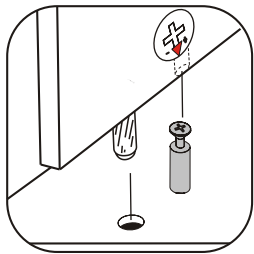
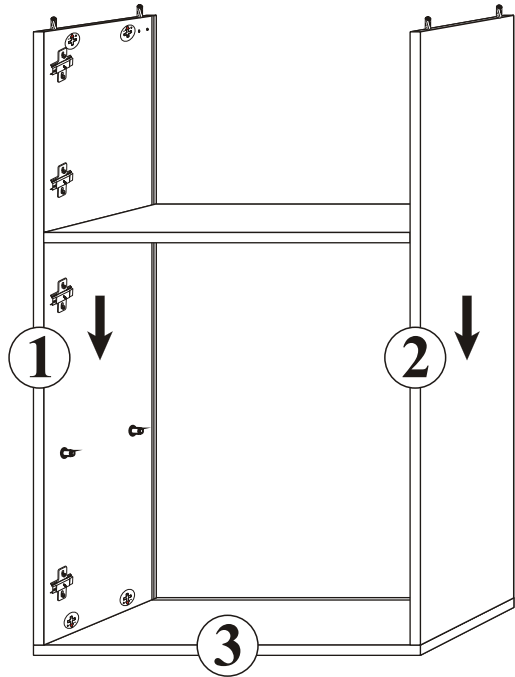

6

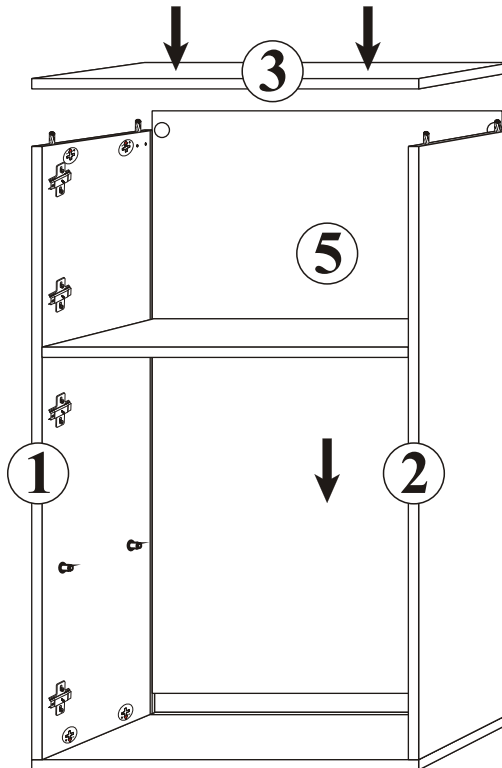
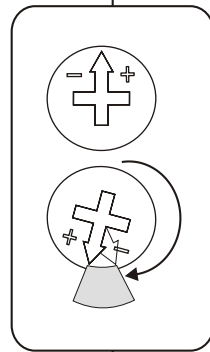
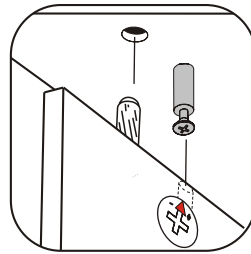

7



a=b

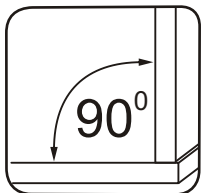
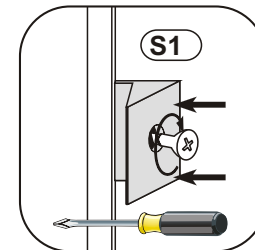
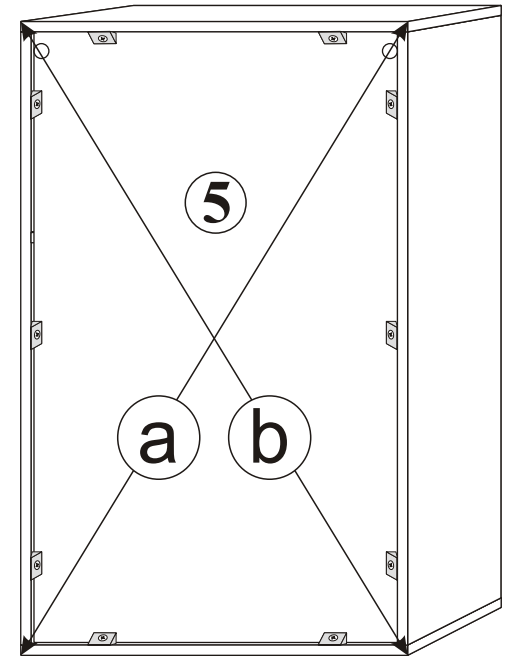

8

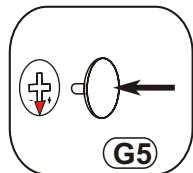
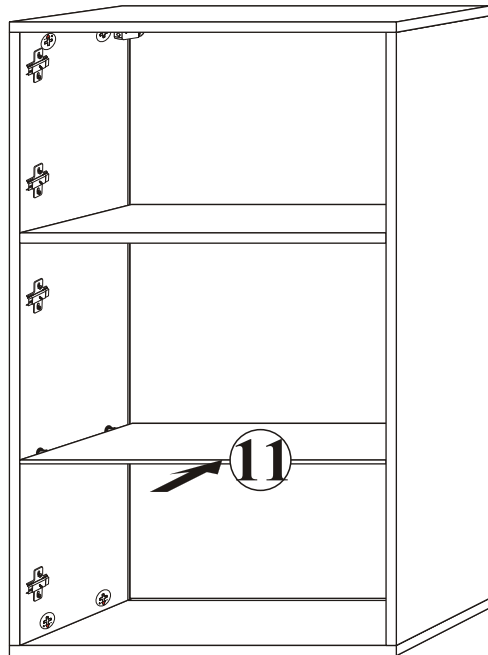
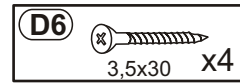
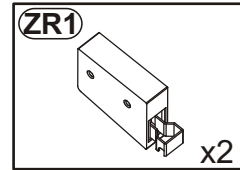
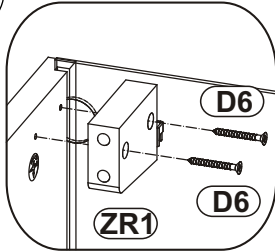

9

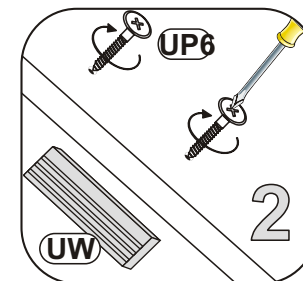
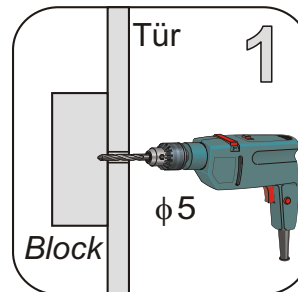
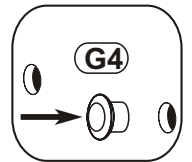
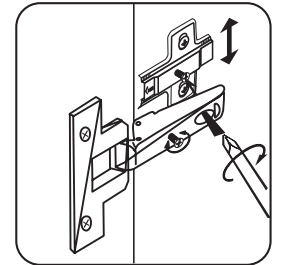
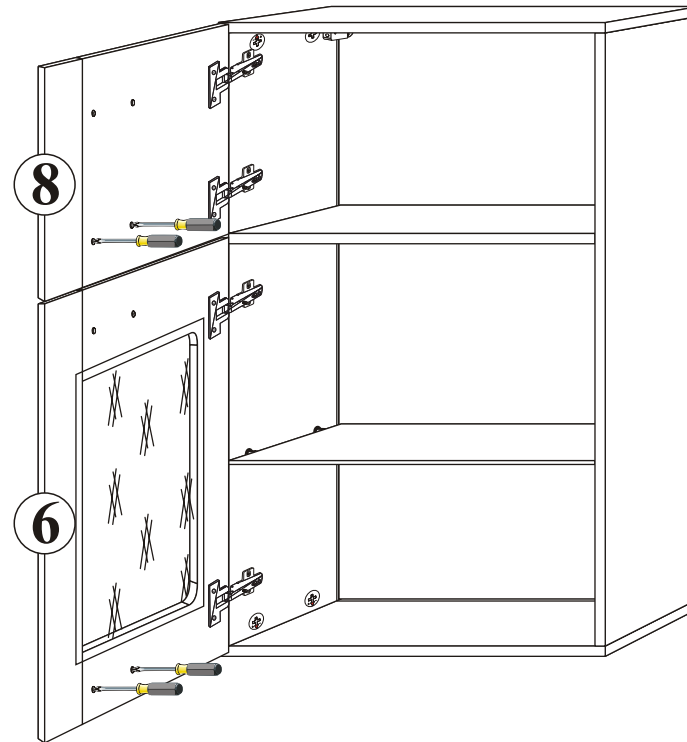
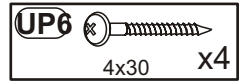
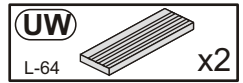
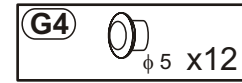

10

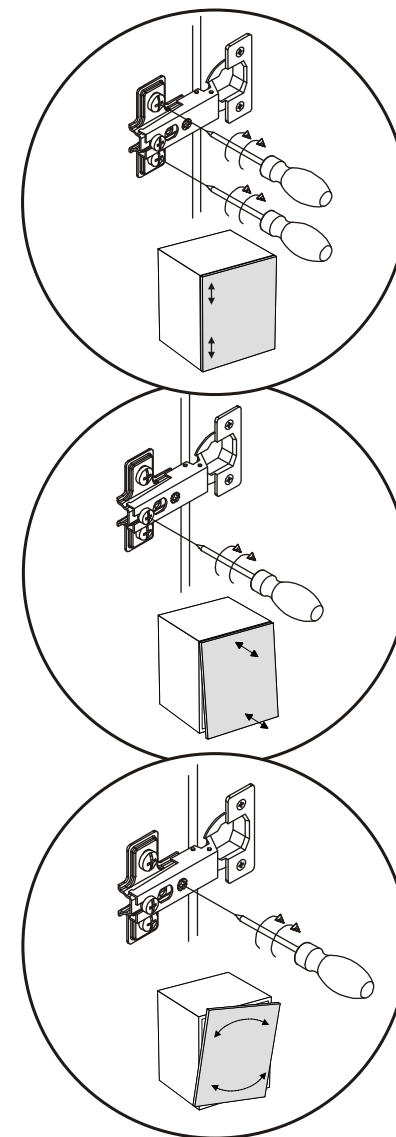
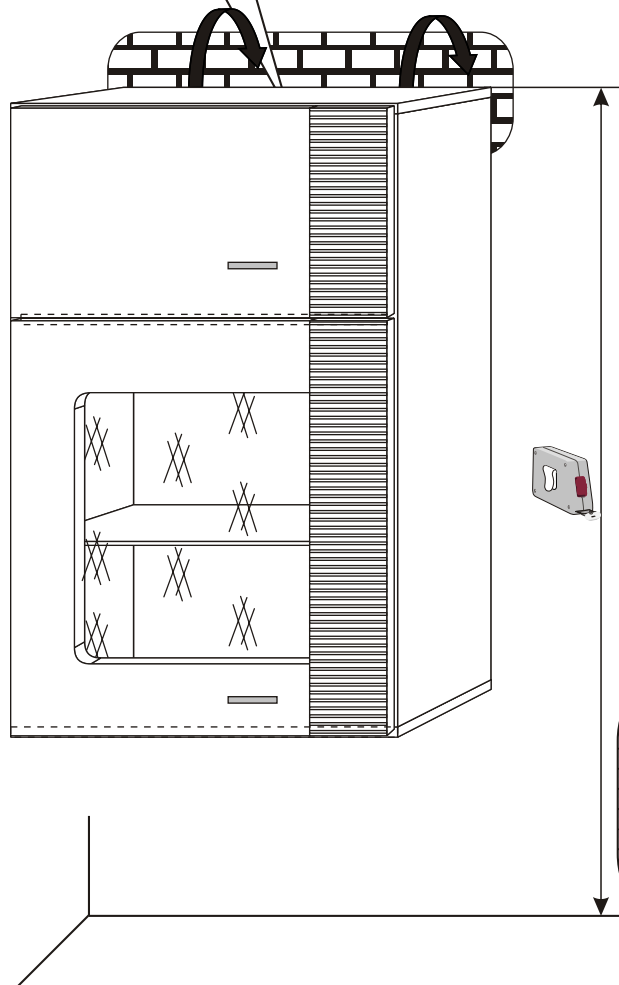
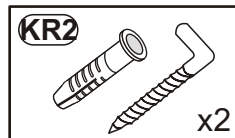

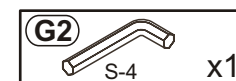
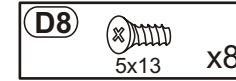
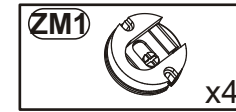
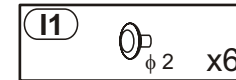
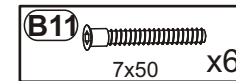
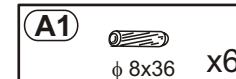
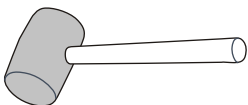
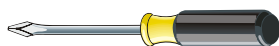
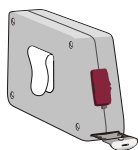
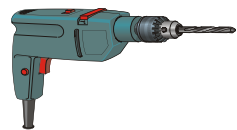
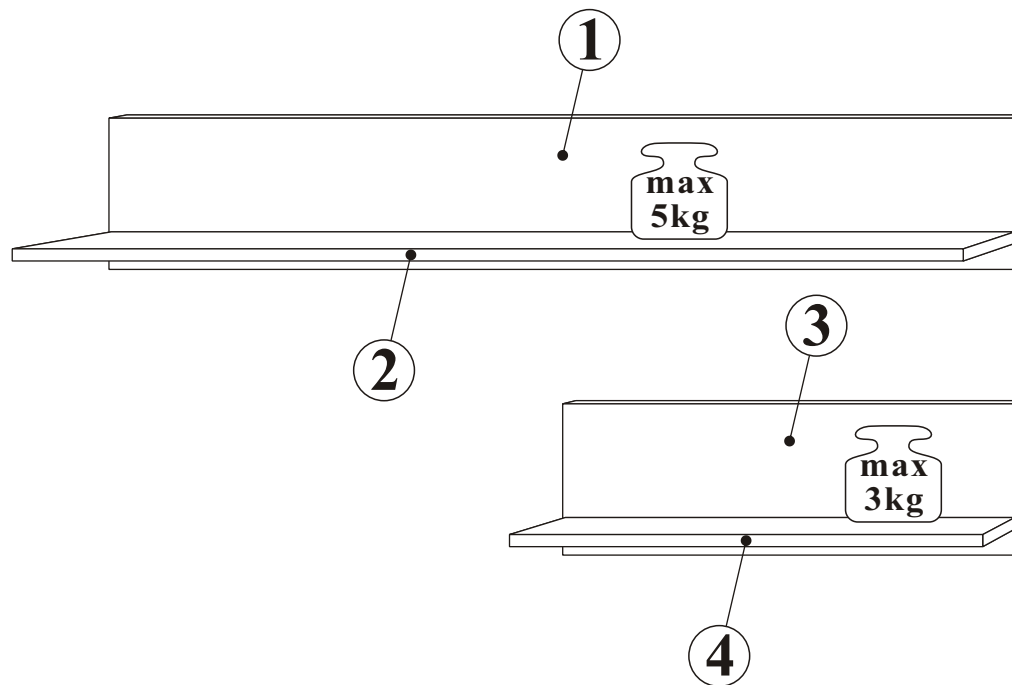
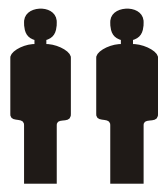
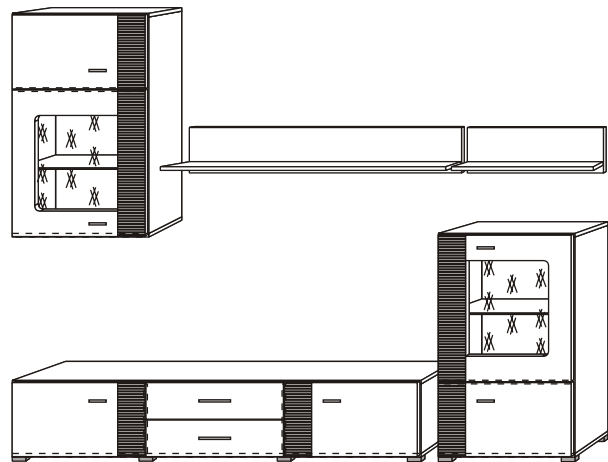

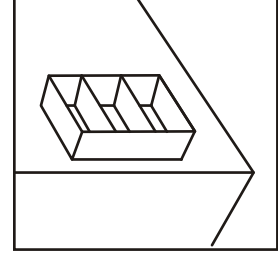
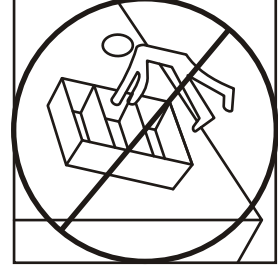
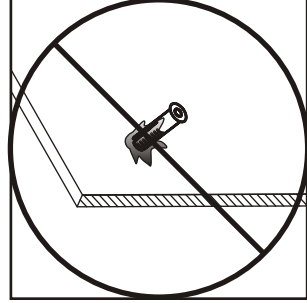
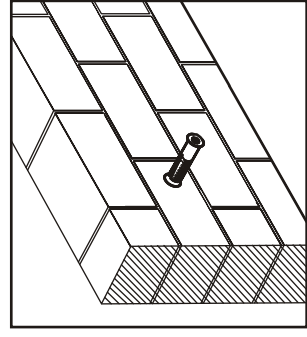
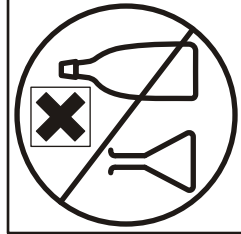
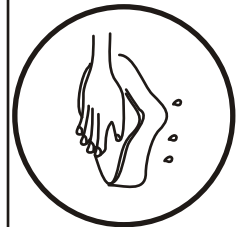
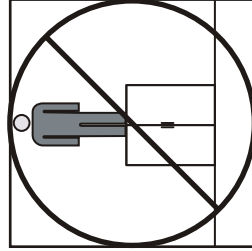
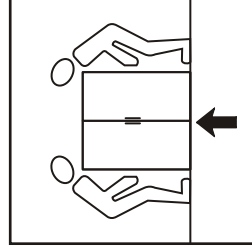
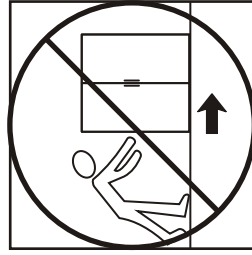
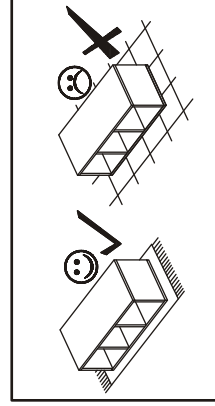
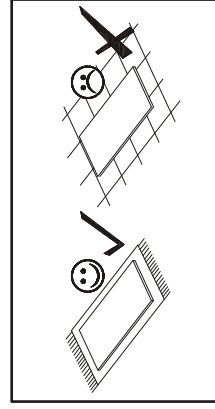
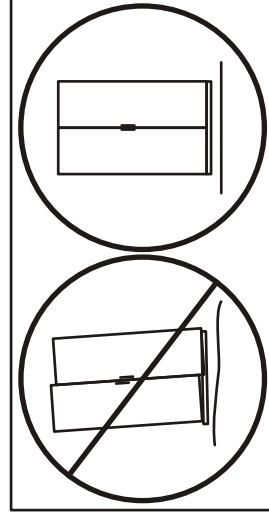
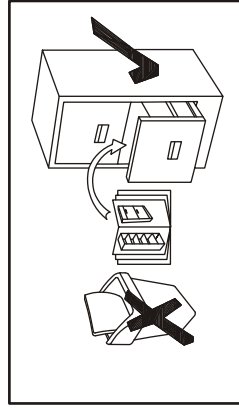
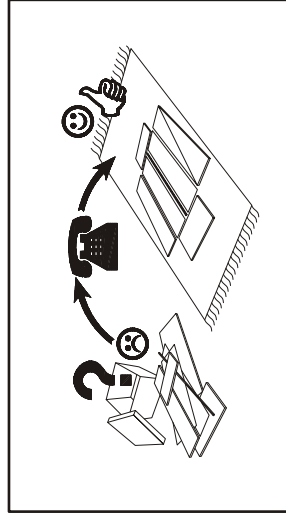

1

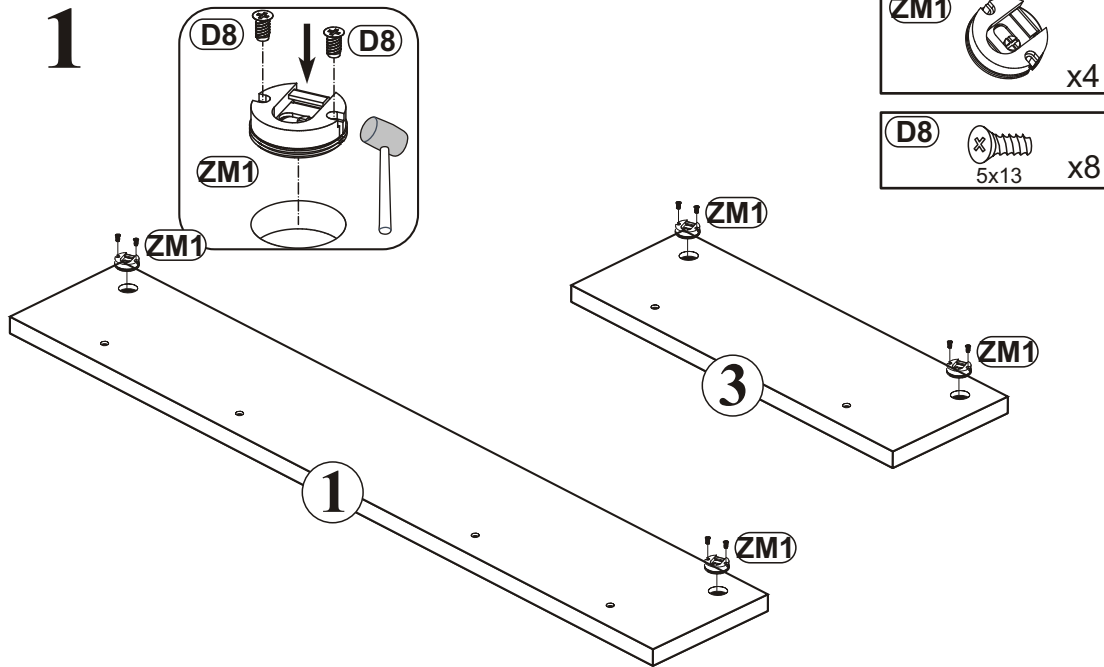

2

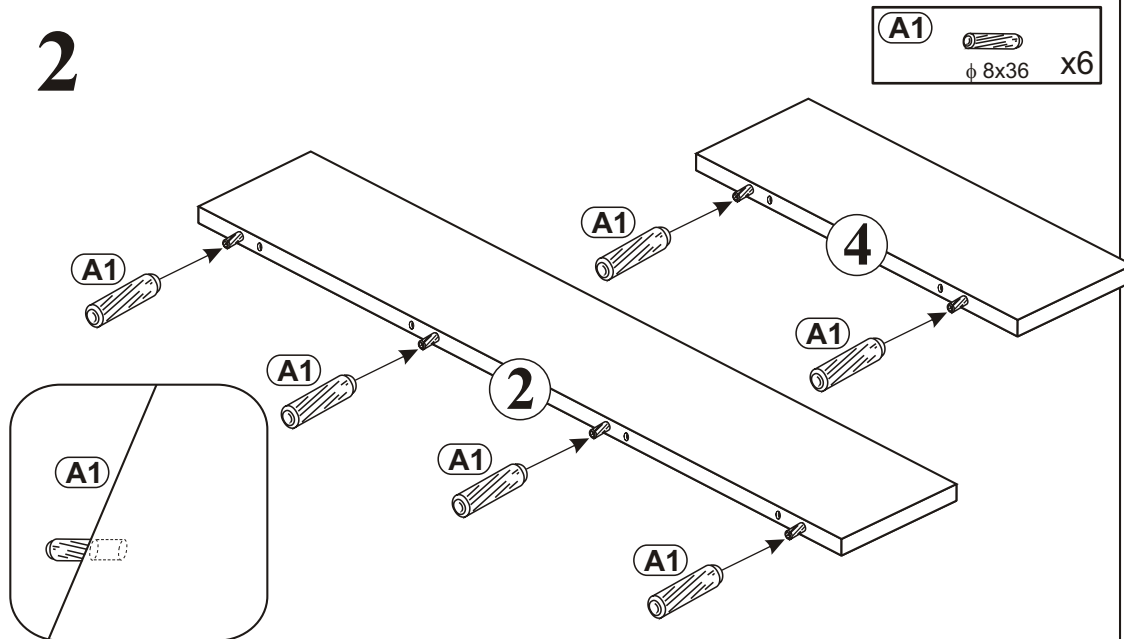

3

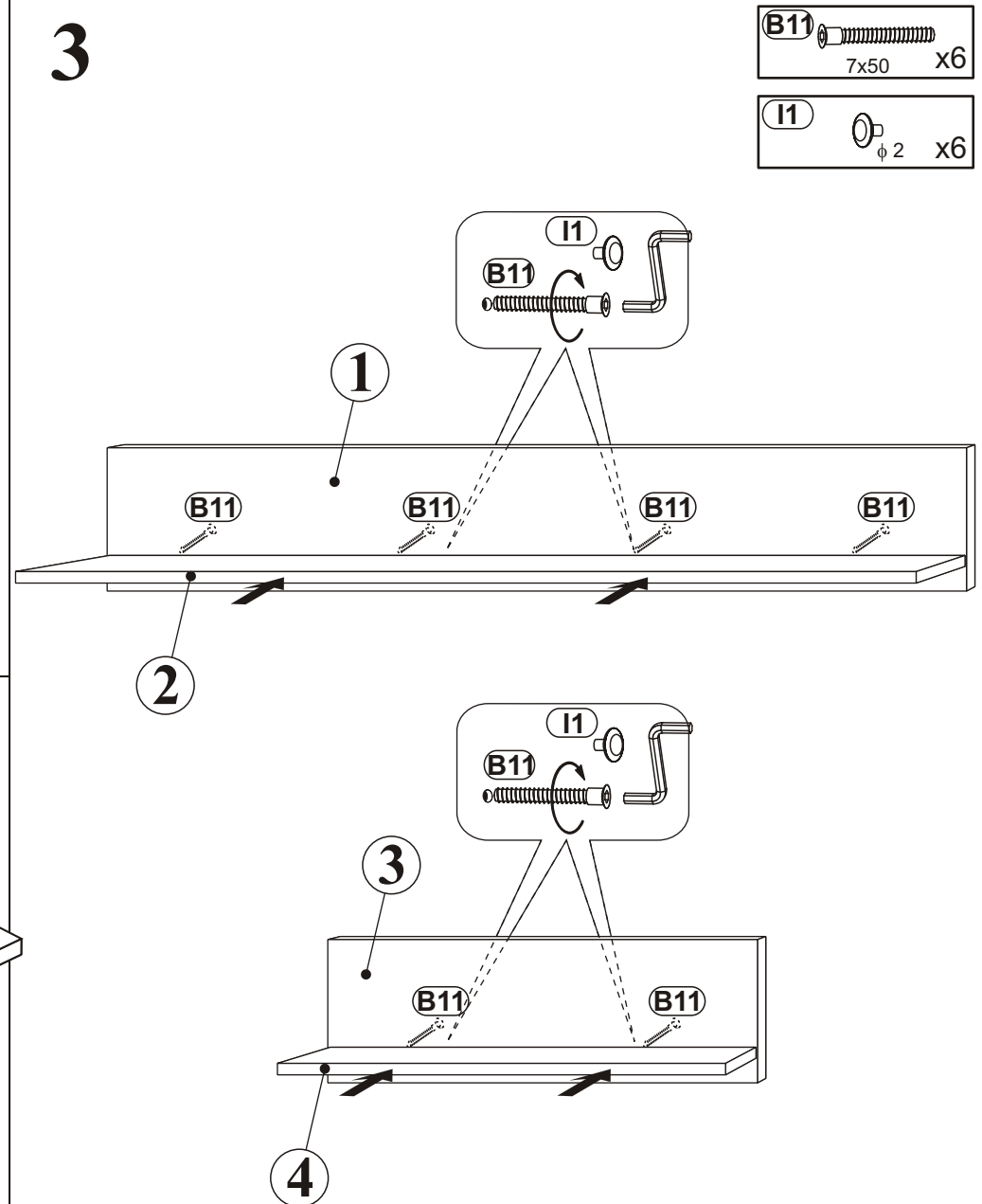

4

